



RJG[®]
M O L D S M A R T

THE HUB[®] SOFTWARE
VIRTUAL APPLIANCE (VA)
PRODUCT MANUAL

Software that provides plant-wide data acquisition and process analysis capabilities for injection molding operations.



THE HUB SOFTWARE VIRTUAL APPLIANCE (VA) PRODUCT MANUAL

CONTENTS

INTRODUCTION	V
DISCLAIMER	V
PRIVACY	V
ALERTS	V
THE HUB SOFTWARE VIRTUAL APPLIANCE (VA) OVERVIEW	1
THE HUB SOFTWARE VA AND COPILOT SYSTEM OVERVIEW	1
THE HUB SOFTWARE VIRTUAL APPLIANCE (VA) OVERVIEW.	1
THE HUB SOFTWARE VA DATA PATH AND LIFE CYCLE	2
DATA FROM COPILOT SYSTEM TO THE HUB SOFTWARE	2
THE HUB SOFTWARE VA DATA BACKUP AND ARCHIVAL	3
Data Backup	3
Data Archival	3
DATA RETENTION AND STORAGE	4
Data Retention	4
Data Storage	4
Required Data Storage Estimates	5
THE HUB SOFTWARE VA DATA SECURITY AND NETWORK SHARE CONFIGURATION USING CLOUD-INIT ..	6
THE HUB SOFTWARE VIRTUAL APPLIANCE (VA) SPECIFICATIONS	7
THE HUB SOFTWARE VA SPECIFICATIONS OVERVIEW	7
HYPERVERSOR OPTIONS	7
APPLICATION SERVER RECOMMENDED SPECIFICATIONS.	7





THE HUB SOFTWARE VIRTUAL APPLIANCE (VA) PRODUCT MANUAL

CONTENTS (CONTINUED)

THE HUB SOFTWARE VIRTUAL APPLIANCE (VA) INSTALLATION	9
INSTALLATION REQUIREMENTS	9
NETWORKING REQUIREMENTS	10
INSTALLATION PROCESS	11
PREREQUISITES	11
IMPORTING AND INSTALLATION OF THE HUB VA FILE	11
Overview	11
Installation with VMWare	11
Installation with HyperV	14
RESIZING THE HUB VA HARD DRIVE SPACE	20
Troubleshooting Virtual Hard Drive Space Resize Failure	25
THE HUB VA NETWORK CONFIGURATION	26
Requirements	26
Configuration Details	27
Checking Network Status	27
Configuring The Hub VA Network	27
LICENSING	29





THE HUB SOFTWARE VIRTUAL APPLIANCE (VA) PRODUCT MANUAL

CONTENTS (CONTINUED)

THE HUB SOFTWARE VIRTUAL APPLIANCE (VA) INIT SERVICE CONFIGURATION	31
THE HUB INIT SERVICE CONFIGURATION	31
THE HUB INSTANCE ID	31
Locating The Hub Instance ID.....	31
TRANSPORT LAYER SECURITY (TLS) OVERVIEW	32
TLS CONFIGURATION	32
REQUIREMENTS	32
EXTRACTING PKCS#7 CERTIFICATE AND PRIVATE KEY FILES FROM PKCS#12 (OPTIONAL)	32
CERTIFICATE CHAINS	32
TLS CONFIGURATION	33
REQUIREMENTS	34
DATA BACKUP & NETWORK SHARE CONFIGURATION	34
JOB BACKUP FILE CONFIRMATION	35
NON-JOB BACKUP FILE CONFIRMATION	36
THE HUB SOFTWARE VIRTUAL APPLIANCE (VA) CONFIGURATION TROUBLESHOOTING	37
TROUBLESHOOTING THE NETWORK SHARE	37
LOCATE NETWORK SHARE FILES	37
TROUBLESHOOTING THE NETWORK SHARE MOUNT	38
Testing the Environment File.....	38
Service	39
Testing the Mount	39
Testing Connectivity	40





THE HUB SOFTWARE VIRTUAL APPLIANCE (VA) PRODUCT MANUAL

CONTENTS (CONTINUED)

THE HUB SOFTWARE VIRTUAL APPLIANCE (VA) RESTORING DATA	41
RESTORING DATA	41
RESTORE JOB DATA FROM A NETWORK SHARE (PREFERRED METHOD).	41
RESTORE JOB DATA BY UPLOAD (ALTERNATE METHOD)	41
RESTORE NON-JOB DATA	42
THE HUB SOFTWARE REPRESENTATIONAL STATE TRANSFER (REST) APPLICATION PROGRAM INTERFACE (API)	43
REQUEST ENDPOINT FOR JOBS	43
RESPONSE PROPERTIES	43
ALARM OBJECTS.	45





THE HUB SOFTWARE VIRTUAL APPLIANCE (VA) PRODUCT MANUAL

INTRODUCTION

Read, understand, and comply with all following instructions. This guide must be kept available for reference at all times.

DISCLAIMER

Inasmuch as RJG, Inc. has no control over the use to which others may put this material, it does not guarantee that the same results as those described herein will be obtained. Nor does RJG, Inc. guarantee the effectiveness or safety of any possible or suggested design for articles of manufacture as illustrated herein by any photographs, technical drawings, and the like. Each user of the material or design or both should make his own tests to determine the suitability of the material or any material for the design as well as the suitability of the material, process, and/or design for his own particular use. Statements concerning possible or suggested uses of the material or designs described herein are not to be construed as constituting a license under any RJG, Inc. patent covering such use or as recommendations for use of such material or designs in the infringement of any patent.

PRIVACY

Designed and developed by RJG, Inc. Manual design, format and structure copyright 2025 RJG, Inc. content documentation copyright 2025 RJG, Inc. All rights reserved. Material contained herein may not be copied by hand, mechanical, or electronic means, either whole or in part, without the express written consent of RJG, Inc. Permission will normally be granted for use in conjunction with inter-company use not in conflict with RJG's best interests.

ALERTS

- ⚠ CAUTION** *A caution is used to make the operator aware of conditions that can cause damage to equipment and/or injury to personnel.*
- 📄 NOTE** *A note provides additional information about a discussion topic.*
- 📖 DEFINITION** *A definition or clarification of a term or terms used in the text.*





THE HUB SOFTWARE VIRTUAL APPLIANCE (VA) OVERVIEW

THE HUB SOFTWARE VA AND COPILOT SYSTEM OVERVIEW

The Hub software VA is a data management system located on virtual machine (VM) that collects, stores, and displays data on a web browser from networked CoPilot systems located on the plant floor.

The CoPilot system consists of a process monitoring and control software application installed on a physical application processor mounted on or near an injection molding machine; the application processor is connected to mold and machine sensors that gather job information for the software.

THE HUB SOFTWARE VIRTUAL APPLIANCE (VA) OVERVIEW

The Hub software is packaged as a virtual appliance (VA). A VA is a virtual version of a hardware device that packages an OS and software application(s), allowing a single file to be remotely installed on a virtual machine (VM) for ease of distribution and management since no locally-installed hardware is required. The Hub software VA includes the operating system (OS), database, cloud instance initialization (cloud-init), and system software in a single, deployable package for installation on a VM.

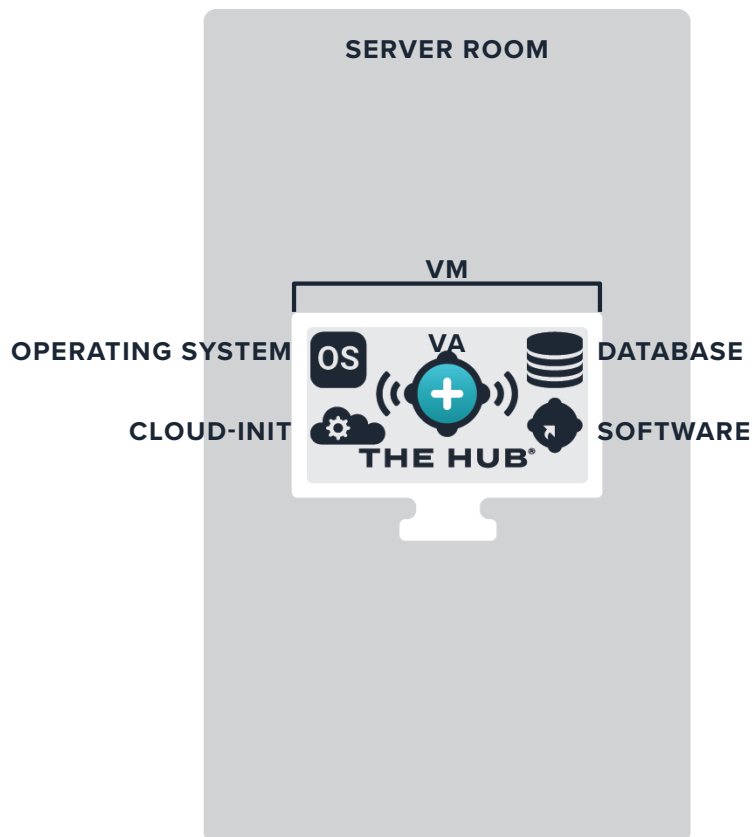



THE HUB SOFTWARE VIRTUAL APPLIANCE (VA) OVERVIEW

THE HUB SOFTWARE VA DATA PATH AND LIFE CYCLE

Data from CoPilot System to The Hub Software

Operators in the plant run jobs on CoPilot systems to collect data from machine and mold sensors and the molding machine. The networked CoPilot systems' data is sent to The Hub software. Below is a diagram of the data path from the CoPilot system to The Hub software.

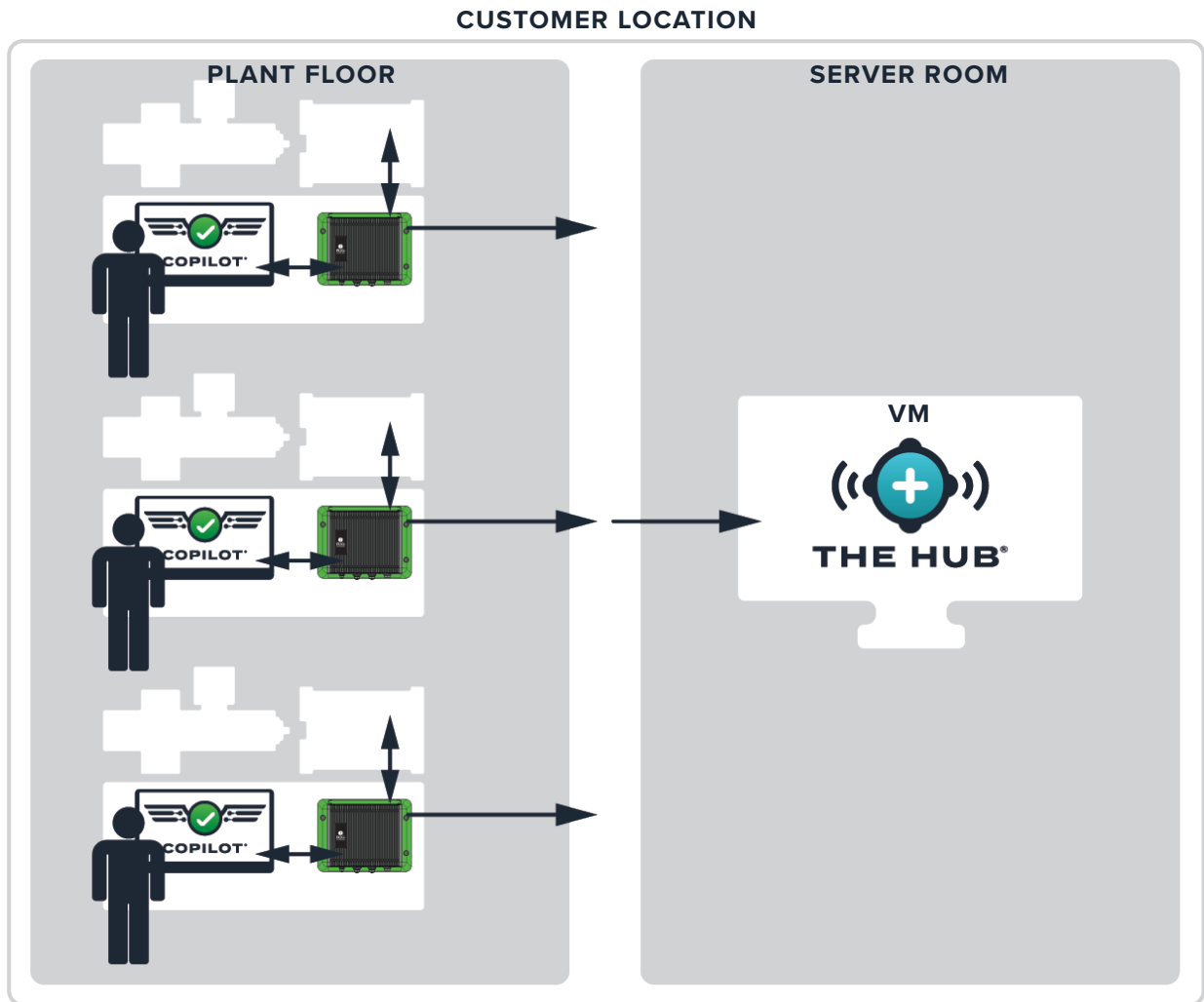



THE HUB SOFTWARE VIRTUAL APPLIANCE (VA) OVERVIEW

The Hub Software VA Data Backup and Archival

Data backup and archival occurs on The Hub for job data and non-job data. Job data is data collected by The Hub software from the CoPilot system when a job is started, running, and stopped. Non-job data is data associated with users, including usernames, roles, and end user license agreement (EULA) records. Both types of data are stored in the .zip format.

Data is collected by the primary data path backup, and remains on The Hub until it is removed by the system administrator (customer), or the system runs out of storage space. The data can be archived by a secondary data location (the secondary data path backup/network share) so that the data is not deleted and the system will not run out of space.

Data Backup

A data backup file can be imported to restore The Hub data, or used to review previously-backed-up data. When a job is complete, all relevant job data is collected and stored.

Data Archival

An archived data file is intended for long-term data retention. When a job is complete, all relevant job data is collected and stored on the network share.

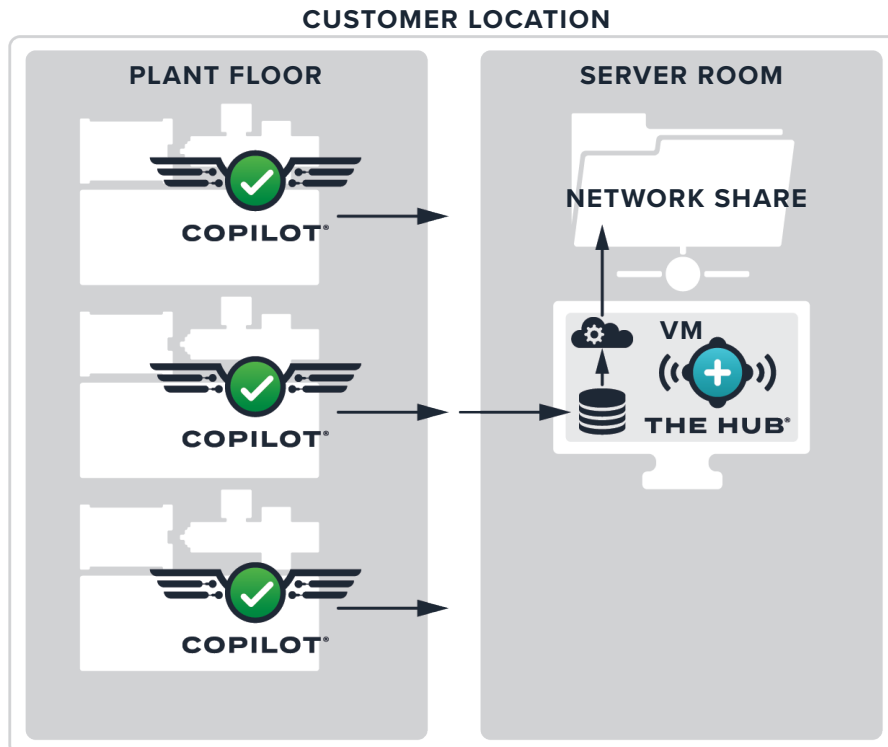



THE HUB SOFTWARE VIRTUAL APPLIANCE (VA) OVERVIEW

Data Retention and Storage

There are two settings configured for data retention and storage. The data retention setting determines how long data is retained in the database after being collected by the primary data path backup, while the data storage setting determines the data storage space for the data collected by the primary data path backup on the system.

Data Retention

When job data is over the data retention date, the cycle and summary data are removed from the database and the job document is updated. Job documents are retained for future access, so job queries are unaffected by data retention settings. The data retention date is determined/set by the customer based on how long the information is needed.

Data Storage

The Hub software will delete job data files if there is not enough storage space, until there is enough storage space. The Hub software will not monitor or remove data for the secondary data location (network share), if one is configured. The customer must ensure that there is enough space to backup data. The system must be configured with enough space to store data in the database for the retention period, and to store the data files long enough for the secondary data path backup/network share to complete data archival.

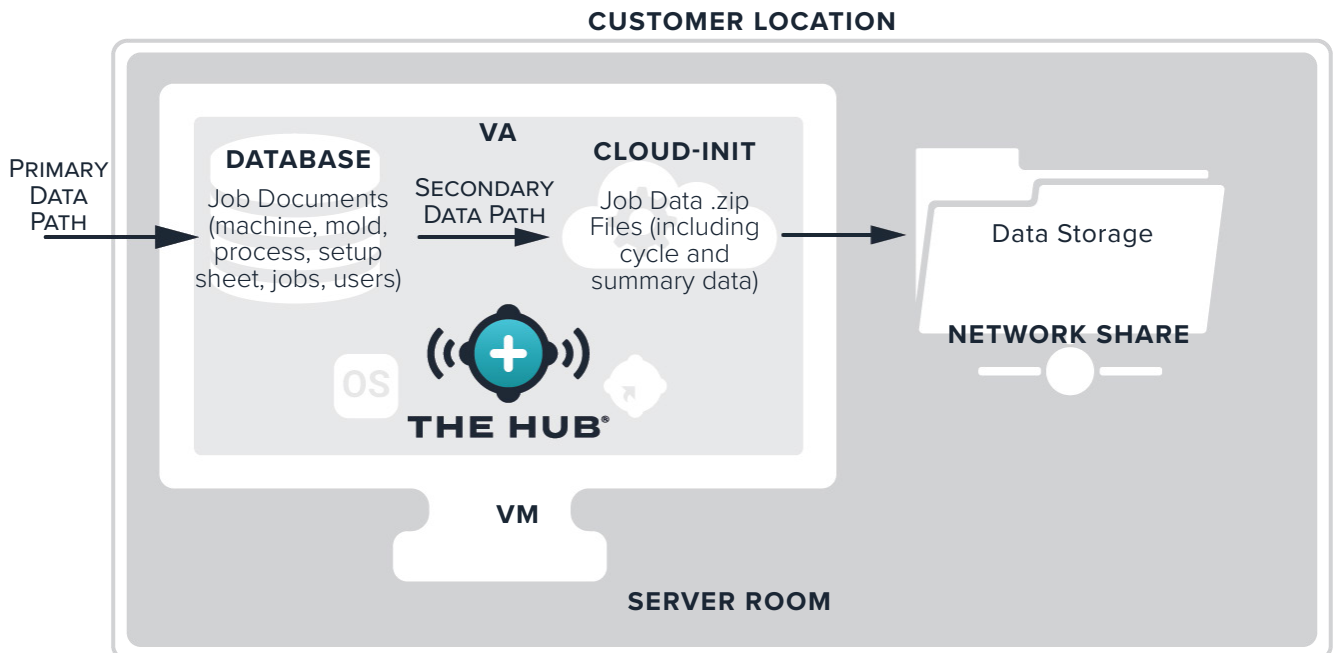



THE HUB SOFTWARE VIRTUAL APPLIANCE (VA) OVERVIEW

Required Data Storage Estimates

The required data storage for archived files will depend upon the operating conditions in the facility. The required data storage can be estimated using the following inputs:

- cycle time (in seconds)
- number of eight-channel strain gage cavity sensor adapters (SG-8)
- number of CoPilot systems
- number of running job hours per day

A Microsoft Excel spreadsheet is available from RJG to input these factors and generate the amount of data generated per day and year; the required data storage can be estimated from these figures. Contact RJG for more information regarding The Hub data rate estimator spreadsheet.





THE HUB SOFTWARE VIRTUAL APPLIANCE (VA) OVERVIEW

The Hub Software VA Data Security and Network Share Configuration Using Cloud-Init

The Hub software cloud-init is a web service that enables the configuration of transport layer security (TLS (encryption)) and the addition/configuration of network shares for data backup with The Hub VA directly from a web form. The Hub VA uses cloud-init; cloud-init is an industry-standard 3rd party tool for configuring cloud images.

The Hub software cloud-init web service is accessible at <https://hub-init.rjginc.com/>.

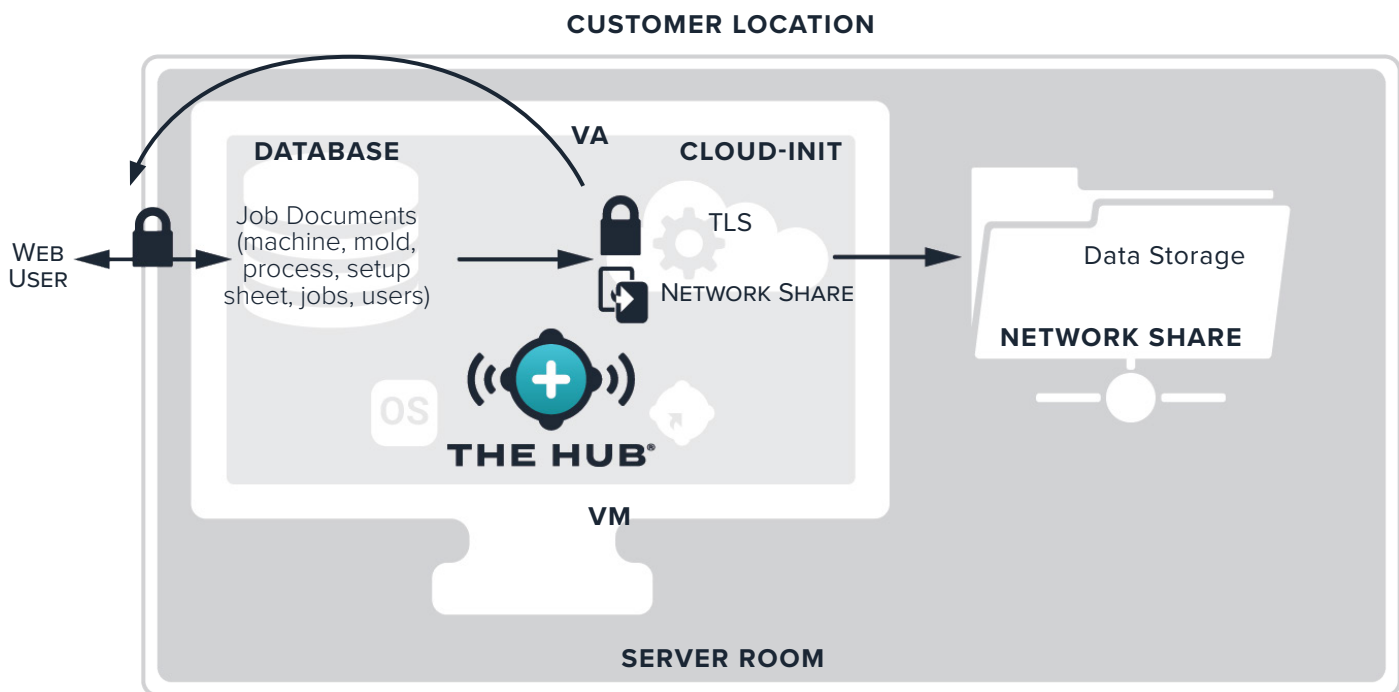



THE HUB SOFTWARE VIRTUAL APPLIANCE (VA) SPECIFICATIONS

THE HUB SOFTWARE VA SPECIFICATIONS OVERVIEW

The following specifications are provided as a guideline and may not be suitable for all applications. RJG will work with customer's IT staff to determine individually-tailored requirements, which will vary depending on many factors, including: primary use, number of networked CoPilot® devices, and data history requirements.

A Hypervisor platform with an application server are required for The Hub VA installation. Select a Hypervisor platform on which to run The Hub VA. The Hub VA will be provided in a virtual hard disk (vhdx) or Open Virtualization Application/Appliance (OVA) file format depending upon the chosen Hypervisor. More platforms support importing an OVA file than are listed below. RJG cannot guarantee success on other platforms, but it may be possible. If a different platform is used, please inform RJG and RJG will work to determine if that platform can successfully host The Hub package.

HYPERVISOR OPTIONS		
VENDOR	PLATFORM	FORMAT
Microsoft	Hyper-V (hyper-v.image)	VHDX
VMware	ESXi 7.0 (any (vmware.image-esxi-vmx-18))	OVA
VMware	ESXi 6.7 U2+ (vmware.image-esxi-vmx-15)	OVA
VMware	ESXi 6.7 (vmware.image-esxi-vmx-14)	OVA

The recommended specifications for the application server are provided below. The resources available should follow the recommendations, but may also be determined by consultation between RJG and the Customer.

APPLICATION SERVER RECOMMENDED SPECIFICATIONS		
RESOURCE	AMOUNT	
Required vCPU	4	
RAM	16 GB, minimum	32 GB, <i>recommended</i>
Hard Drive	1 TB, <i>minimum</i>	





THE HUB SOFTWARE VIRTUAL APPLIANCE (VA) INSTALLATION

INSTALLATION REQUIREMENTS

- A virtualization host system as listed under "Hypervisor Options" on page 7.
- Resources available on the selected Hypervisor defined in "Application Server Recommended Specifications" on page 7, or as determined by consultation between RJG and the Customer
- Network Firewall and Routing Configuration
 - Set to allow RJG SSH access to the VA (required at installation time)
 - Set to allow access to CoPilot system network
 - Set to allow web access to users
 - Set to allow system update
 - The Hub VA to receive DHCP address (required at time of installation).
- Local IT contact
 - RJG to receive necessary local IT contact information
 - During the planning phase, before installation or delivery of VA, one consultation is required between the Customer IT and RJG.
 - RJG and Local IT will collaborate on remote installation. There are a few steps that require RJG to handle, like license generation. The Customer may drive the installation with RJG supporting and handling the license step, or RJG can drive the installation alongside Customer's IT.





THE HUB SOFTWARE VIRTUAL APPLIANCE (VA) INSTALLATION

Networking Requirements

The Hub system communicates with the CoPilot system network and the office network for web users. This table describes the IP traffic details that must be allowed by the network.

PURPOSE	NETWORK	PROTOCOL AND PORT
CoPilot Data, Configuration	The Hub←CoPilot	TCP 22, 55333
The Hub Web Access	The Hub←Office	TCP 80, 8000, 443*
System Update	The Hub→Internet	TCP 443**
CoPilot Debugging	RJG Support→CoPilot	SSH 22

*required if TLS support is enabled on The Hub VA

**accesses the following domains:

<https://rjg-release-server-pointers.s3.us-east-2.amazonaws.com>,
<https://rjg-release-server-store.s3.us-east-2.amazonaws.com>, and
<https://cache.nixos.org>

Default (without SSL):

- HTTP port 80 to The Hub
 - example connection string: `http://hubip/`
- WS port 8000 to The Hub
 - example connection string: `ws://hubip:8000/ws/v1/system`

When SSL Configured:

- HTTPS port 443 to The Hub
 - example connection string: `https://hubip/`
- WSS port 443 to The Hub
 - example connection string: `wss://hubip/ws/v1/system`





THE HUB SOFTWARE VIRTUAL APPLIANCE (VA) INSTALLATION

INSTALLATION PROCESS

Prerequisites

- Identify which Hypervisor will be used to run The Hub software VA, then notify RJG Support representative of Hypervisor chosen.
- Download The Hub VA image via download link supplied by RJG Support.
- Set up host (Hypervisor) on which to install The Hub VA.

Importing and Installation of The Hub VA File

Overview

1. RJG will create The Hub VA in the pre-determined format (OVA/VHDX) and transfer the file to the customer.
2. The customer will install the VA in the chosen Hypervisor as a new VM, allocate DHCP resources to the VA, and boot up the VA.
3. RJG and the customer will administer the VA, license the VA, and setup the Admin user in conjunction.
4. The Hub initialization (init) service can be configured to provide transport layer security (TLS) and data backup/network share options; refer to "The Hub Software Virtual Appliance (VA) INIT Service configuration" on page 31x.

Import The Hub software image to the Hypervisor system or storage that is accessible to that system using the following instructions.

- If using VMware, refer to pages 12–15.
- If using HyperV, refer to pages 16–19.





THE HUB SOFTWARE VIRTUAL APPLIANCE (VA) INSTALLATION



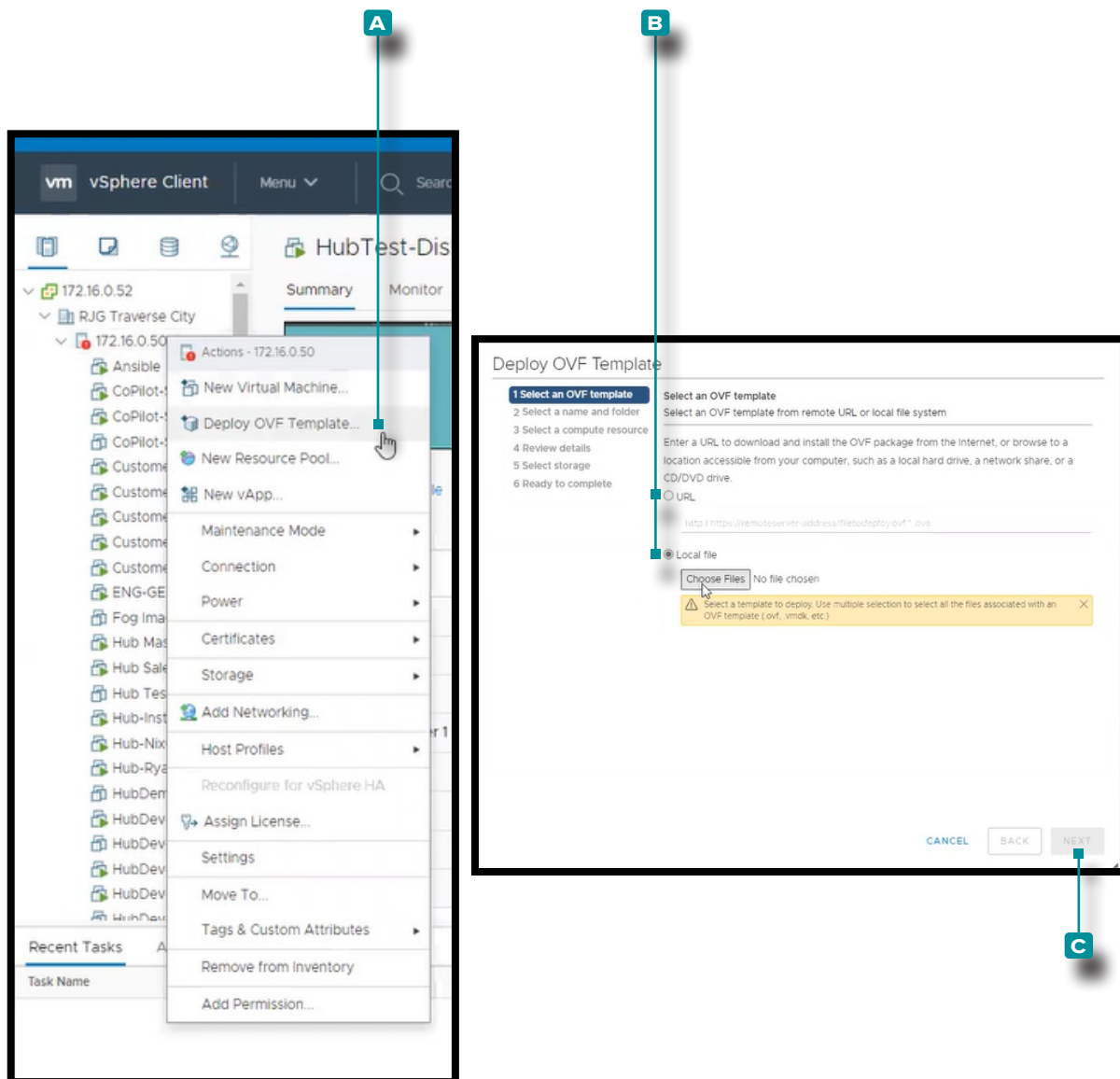

Installation with VMWare

1. In the vSphere client, **right click** the selected host, then **click** **A** Deploy OVF Template.
2. The Deploy OVF Template window will appear; select the OVF template from either a **B** URL or Local File (the .ova file format is provided for esxi or vmware; the .ova file can be deleted from the download folder after it is installed). **Click** the **C** NEXT button.



THE HUB SOFTWARE VIRTUAL APPLIANCE (VA) INSTALLATION

Installation with VMWare

- In the Deploy OVF Template/Select a name and folder window, **click**  the **A** field, then enter a Virtual machine name. **Click**  to select a **B** location from the box, then **click**  the **C** NEXT button. A **D** validating window may appear.
- In the Deploy OVF Template/Select a computer resource window, **click**  the **E** destination resource from the list, then **click**  the **F** NEXT button.

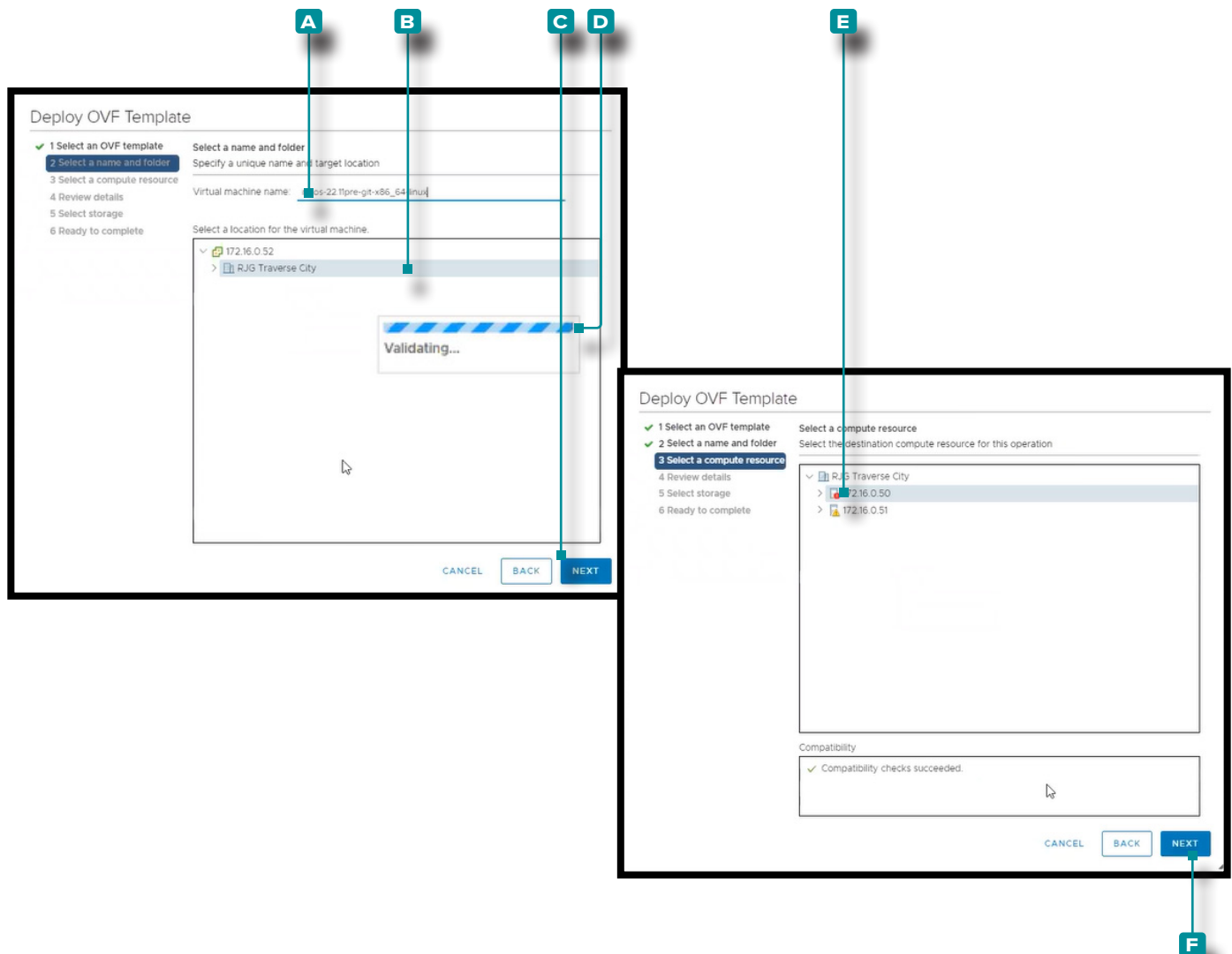



THE HUB SOFTWARE VIRTUAL APPLIANCE (VA) INSTALLATION

Installation with VMWare

5. The Deploy OVF Template/Review details window displays a summary of selected settings; **click**  the **A** NEXT button.
6. In the Deploy OVF Template/Select storage window, **click**  a **B** datastore for the configuration and disk files, then **click**  the **C** NEXT button.

Deploy OVF Template

1 Select an OVF template
2 Select a name and folder
3 Select a compute resource
4 Review details
5 Select storage
6 Select networks
7 Ready to complete

Review details
Verify the template details.

Publisher	No certificate present
Product	The Hub
Version	7.1.1
Vendor	RJG, Inc.
Description	Monitor the CoPilot Systems on your plant floor.
Download size	2.2 GB
Size on disk	Unknown (thin provisioned) 50.0 GB (thick provisioned)

CANCEL BACK **NEXT**

Deploy OVF Template

1 Select an OVF template
2 Select a name and folder
3 Select a compute resource
4 Review details
5 Select storage
6 Select networks
7 Ready to complete

Select storage
Select the datastore in which to store the configuration and disk files

Encrypt this virtual machine (Requires Key Management Server)

Select virtual disk format: Thick Provision Lazy Zeroed

VM Storage Policy: Datastore Default

Name	Capacity	Provisioned	Free	Type
MainDataStore	402.5 GB	1.41 GB	401.09 GB	VM
PrimaryDataStore	10.92 TB	7.8 TB	4.72 TB	VM
SecondaryDataStore	476.75 GB	1.41 GB	475.34 GB	VM

Compatibility
✓ Compatibility checks succeeded.

CANCEL BACK **NEXT**





THE HUB SOFTWARE VIRTUAL APPLIANCE (VA) INSTALLATION

Installation with VMWare

7. In the Deploy OVF Template/Select networks window **click** the **A** destination network for installation, then **click** the **B** NEXT button.
8. The Deploy OVF Template/Ready to complete displays another summary of selected options; the Size on Disk defaults to 50 GB, while RJG recommends 1 TB. **Click** the **C** Finish button, then resize the disk size using the instructions found in "Resizing The Hub VA Hard Drive Space" on page 21.

Deploy OVF Template

1 Select an OVF template
2 Select a name and folder
3 Select a compute resource
4 Review details
5 Select storage
6 Select networks
7 Ready to complete

Select networks
Select a destination network for each source network.

Source Network	Destination Network
NAT	192.168.XXX VM's

IP Allocation Settings
IP allocation: Static - Manual
IP protocol: IPv4

A **B**

CANCEL BACK **NEXT**

Deploy OVF Template

1 Select an OVF template
2 Select a name and folder
3 Select a compute resource
4 Review details
5 Select storage
6 Select networks
7 Ready to complete

Ready to complete
Click Finish to start creation.

Provisioning type	Deploy from template
Name	Hub-Demo-NixOs
Template name	nixos-22.11pre-git-x86_64-linux
Download size	2.2 GB
Size on disk	50.0 GB
Folder	RJG Traverse City
Resource	172.16.0.50
Storage mapping	1
All disks	Datastore: PrimaryDataStore, Format: Thick provision lazy zeroed
Network mapping	1
NAT	172.16.0.XXX VM's
IP allocation settings	
IP protocol	IPv4

CANCEL BACK **FINISH**

C



THE HUB SOFTWARE VIRTUAL APPLIANCE (VA) INSTALLATION

Installation with HyperV

1. In the HyperV Manager, **click** **A** Action, **click** **B** New, then **click** **C** Virtual Machine; the New Virtual Machine Wizard will appear.
2. In the New Virtual Machine Wizard/Before you Begin window, **click** **D** the Next button.

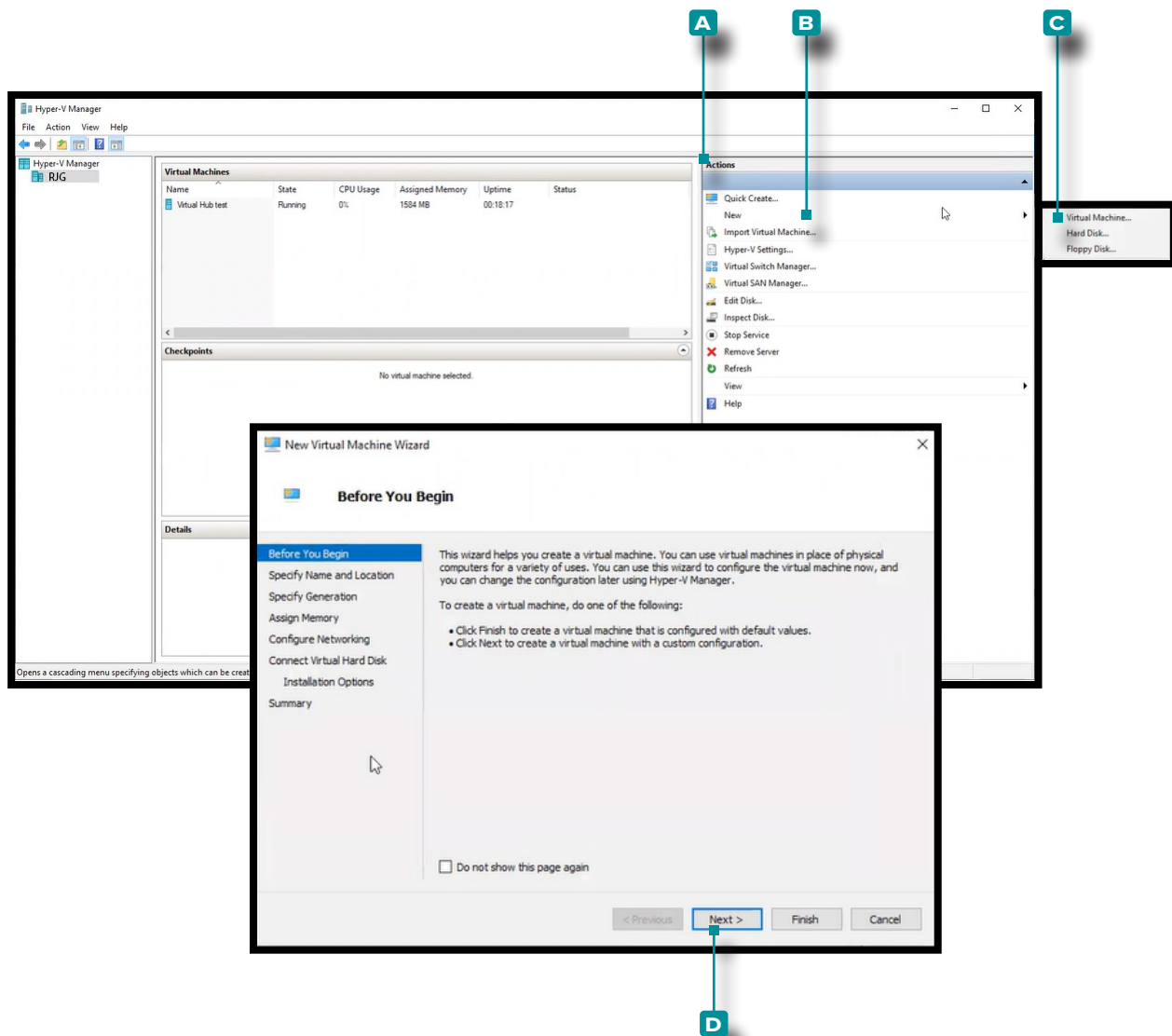



THE HUB SOFTWARE VIRTUAL APPLIANCE (VA) INSTALLATION

Installation with HyperV

3. In the New Virtual Machine Wizard/Specify Name and Location window, **click** **A** the field and enter a Name; if desired, **click** **B** the box to select different storage location than the one present (**click** the browse button, **click** to select the location, **click** the Open button). **Click** **C** Next button to continue.
4. In the New Virtual Machine Wizard/Specify Generation window, **click** to select **D** Generation 2 (generation 1 will not work), then **click** the **E** Next button.

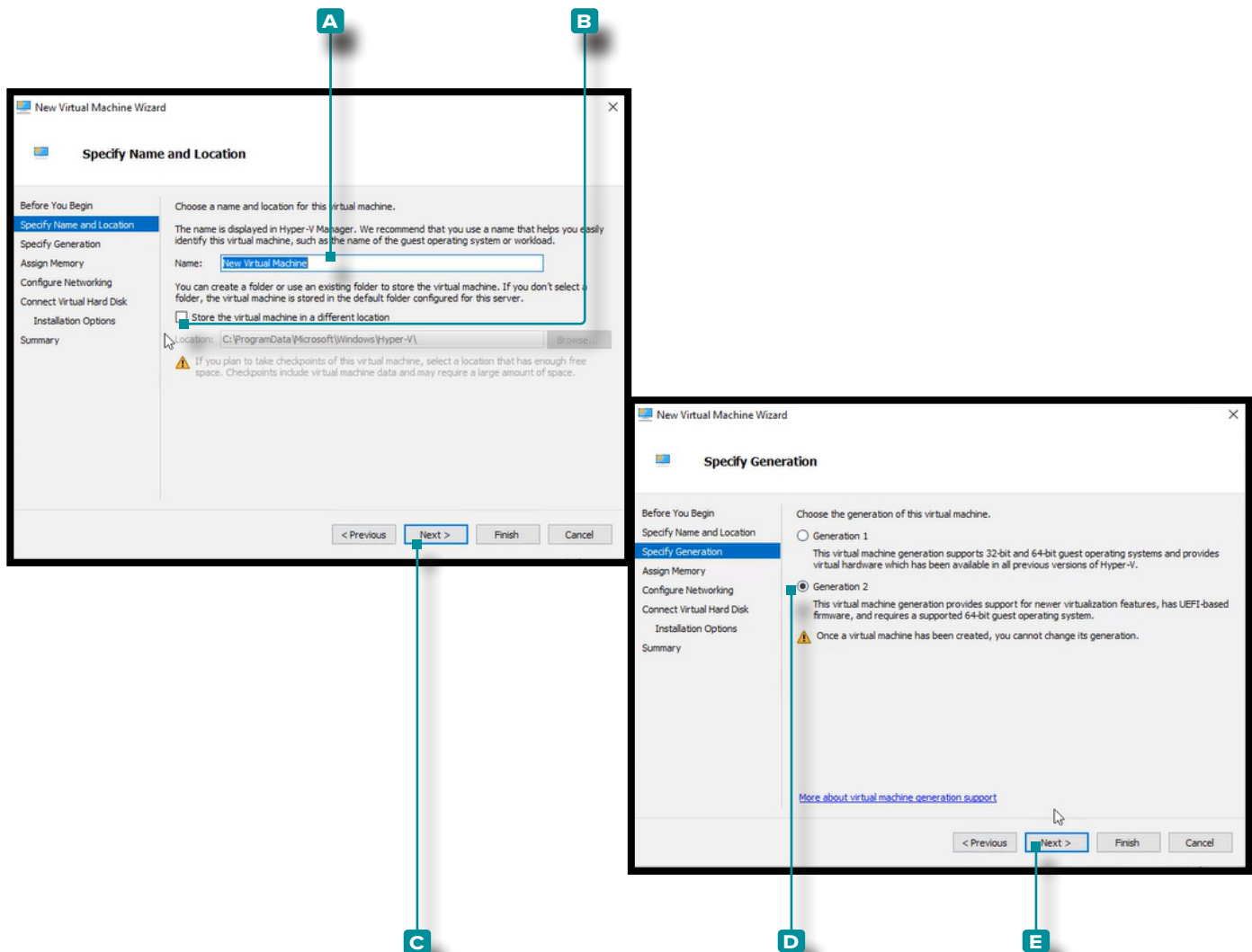



THE HUB SOFTWARE VIRTUAL APPLIANCE (VA) INSTALLATION

Installation with HyperV

- In the New Virtual Machine Wizard/Assign Memory window, startup memory defaults to 1024 MB. **Click** ^A the **A** field, then enter the startup memory; the startup memory must be increased to at least 16 GB, with 32 being recommended. **Click** ^B the **B** Next button to continue.
- In the New Virtual Machine Wizard/Configure Networking window, **click** ^C the **C** connection type "default switch" from the drop-down menu, then **click** ^D the **D** Next button.

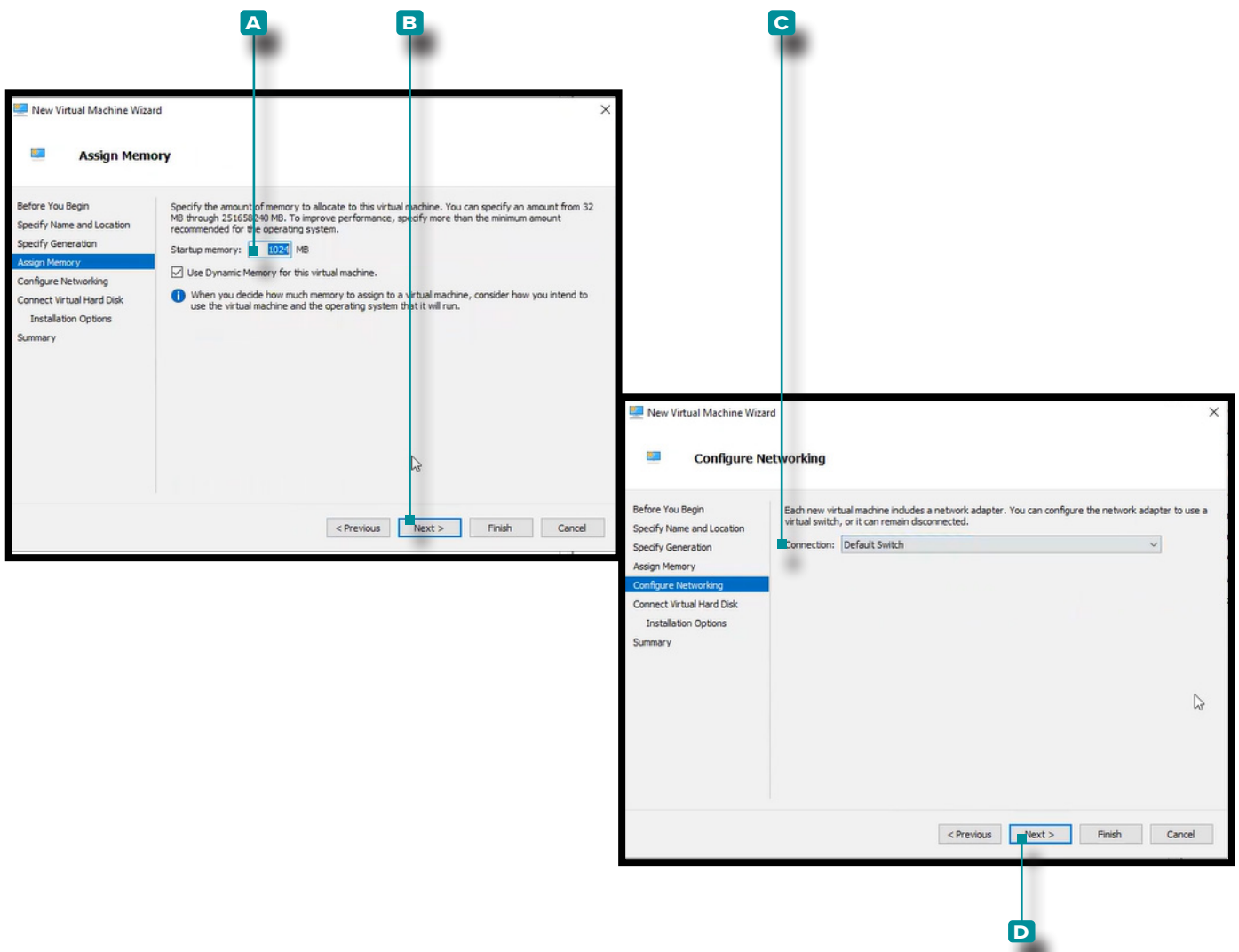



THE HUB SOFTWARE VIRTUAL APPLIANCE (VA) INSTALLATION

Installation with HyperV

7. In the New Virtual Machine Wizard/Connect Virtual Hard Disk/Installation Options window, **click** **A** use an existing virtual hard disk, then **click** **B** browse button to browse for location (this is the .vdx download file provided by RJG). **Click** **C** the .vhd file (~8 GB in size), **click** the Open button, then **click** **C** Next button.

NOTE *The .vhd file must be stored on the machine and cannot be deleted.*

8. The New Virtual Machine Wizard/Summary window displays a summary of selected options; **click** **D** Finish button.

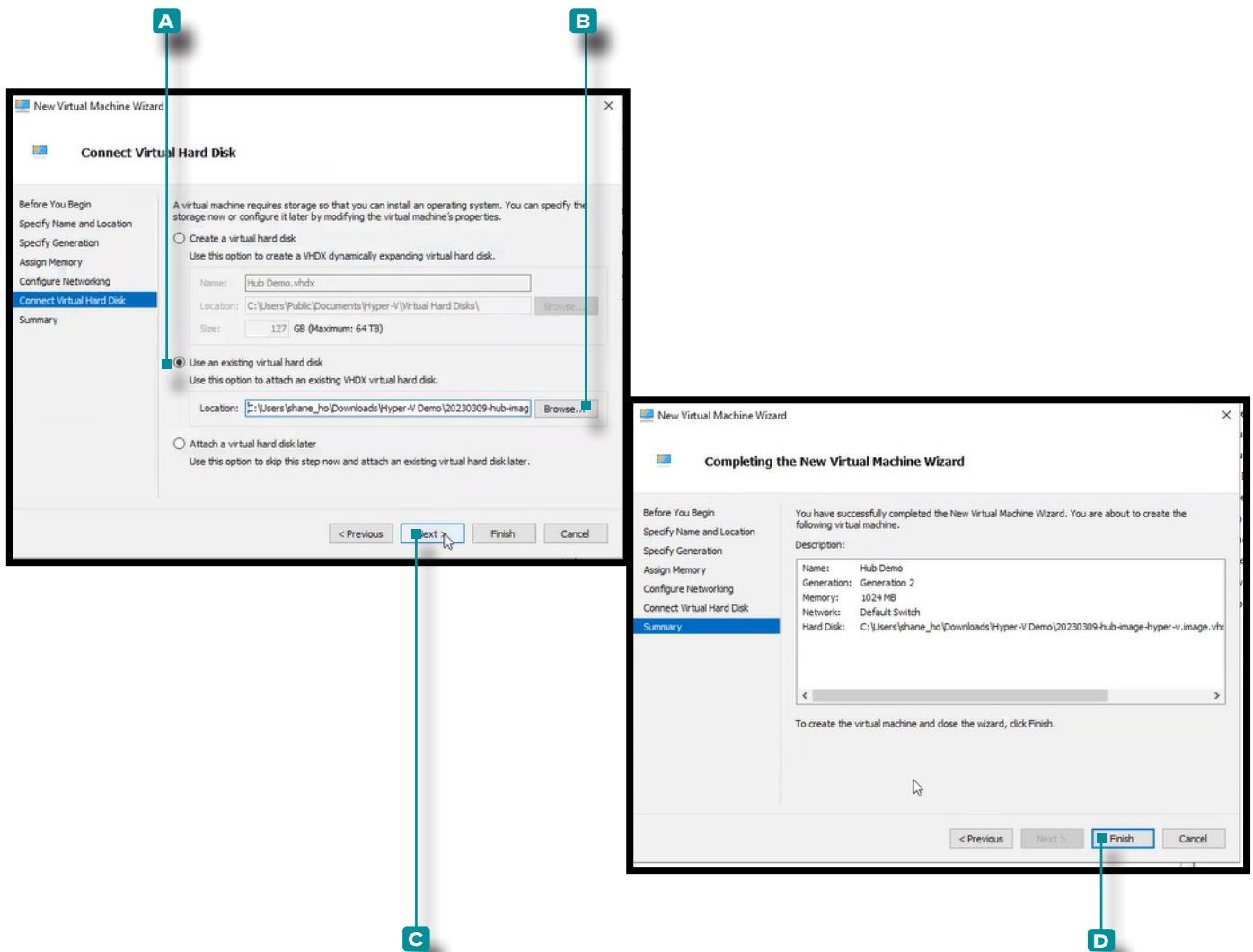



THE HUB SOFTWARE VIRTUAL APPLIANCE (VA) INSTALLATION

Installation with HyperV

9. Power off the virtual machine.
10. Right click the VM, then click **A** Settings; the Settings window will appear.
11. In the Settings window, click **B** Security, click the **C** Enable Secure Boot check box to deselect it, then click the **D** Apply button.

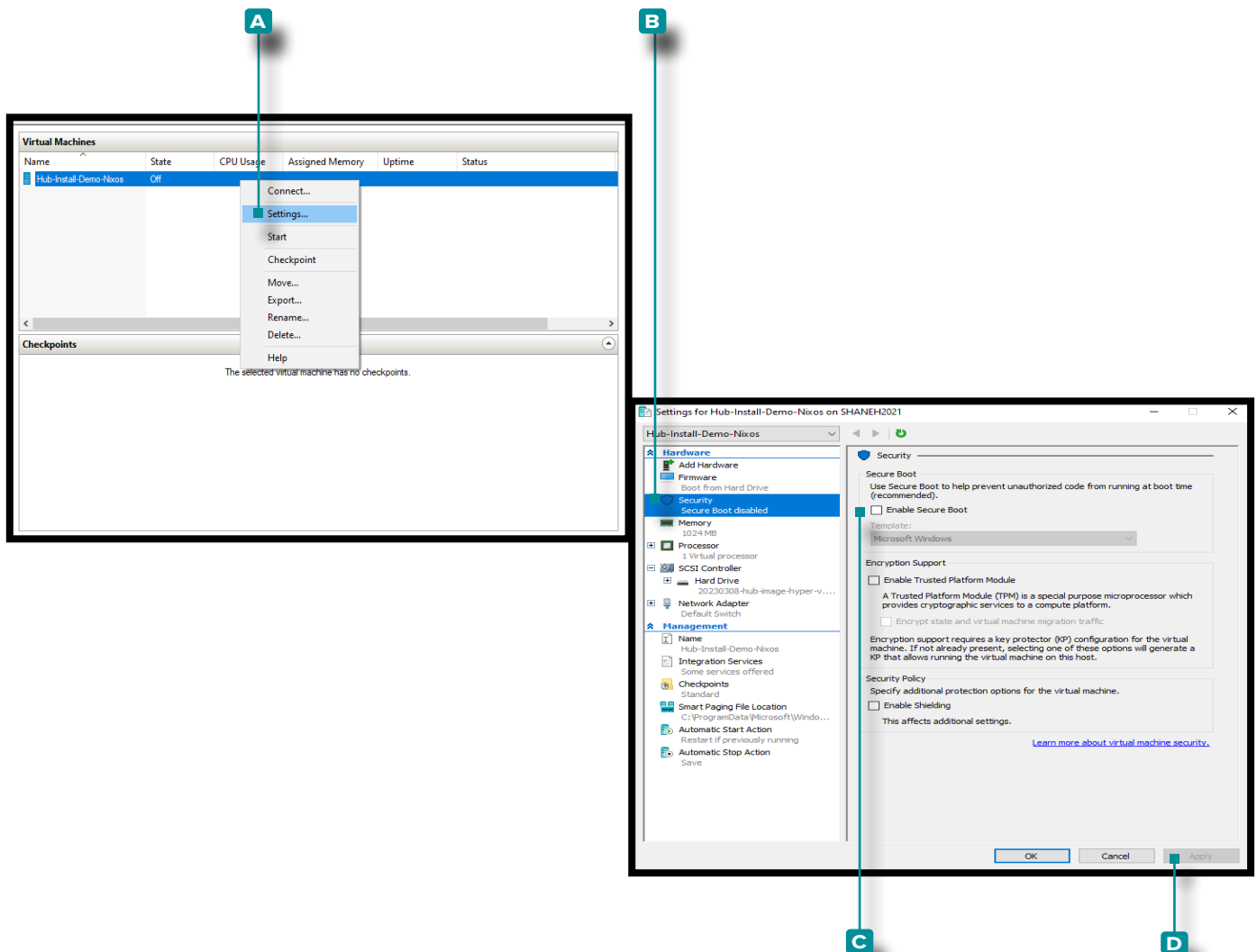



THE HUB SOFTWARE VIRTUAL APPLIANCE (VA) INSTALLATION

Resizing The Hub VA Hard Drive Space

After the virtual image is loaded onto the chosen hypervisor, it may be necessary or desired to increase the storage space on the virtual machine. Perform the following instructions to increase the storage space on the particular hypervisor.

Resizing the Hard Drive Space with VMware

1. Power off the virtual machine.
2. In the **A** VMware Navigator window, ensure the machine name is highlighted.
3. Click **B** the Edit button in the window.
4. Click **C** and enter the desired amount of storage in the provided field.
5. Click **D** the Save button to save the changes, or click **E** the Cancel button to cancel any changes.
6. Confirm the disk space has been upgraded once the machine is running.

The screenshot shows the VMware ESXi interface. The 'Edit settings' window for a virtual machine is open, showing the 'Virtual Hardware' tab. The 'Hard disk 1' field is highlighted with a blue box and labeled 'C'. The 'Save' button is labeled 'D' and the 'Cancel' button is labeled 'E'. A terminal window is overlaid on the bottom left, showing the output of the 'df -h' command. The output is as follows:

```
[rjguser@TheHub:~]$ df -h
Filesystem      Size  Used Avail Use% Mounted on
devtmpfs        198M   0    198M   0% /dev
tmpfs           2.0G   8.0K  2.0G   1% /dev/shm
tmpfs           986M   7.0M  979M   1% /run
tmpfs           2.0G  384K  2.0G   1% /run/wrappers
/dev/disk/by-label/nixos 99G   7.1G  87G   8% /
tmpfs           4.6M   0    4.0M   0% /sys/fs/cgroup
tmpfs           2.0G   68K  2.0G   1% /tmp
```



Resizing the Hard Drive Space with HyperV

Resizing the Hard Drive Space with Hyper-V

1. Power off the virtual machine.
2. In the **A** Hyper-V Manager window, ensure the machine name is highlighted.
3. Click **B** Actions to open the drop-down window, then click **C** Edit Disk from the drop-down window; the **D** Edit Virtual Hard Disk Wizard will open.
4. Click **E** the Next button on the **D** Edit Virtual Hard Disk Wizard, Before You Begin page.

(continued on next page)

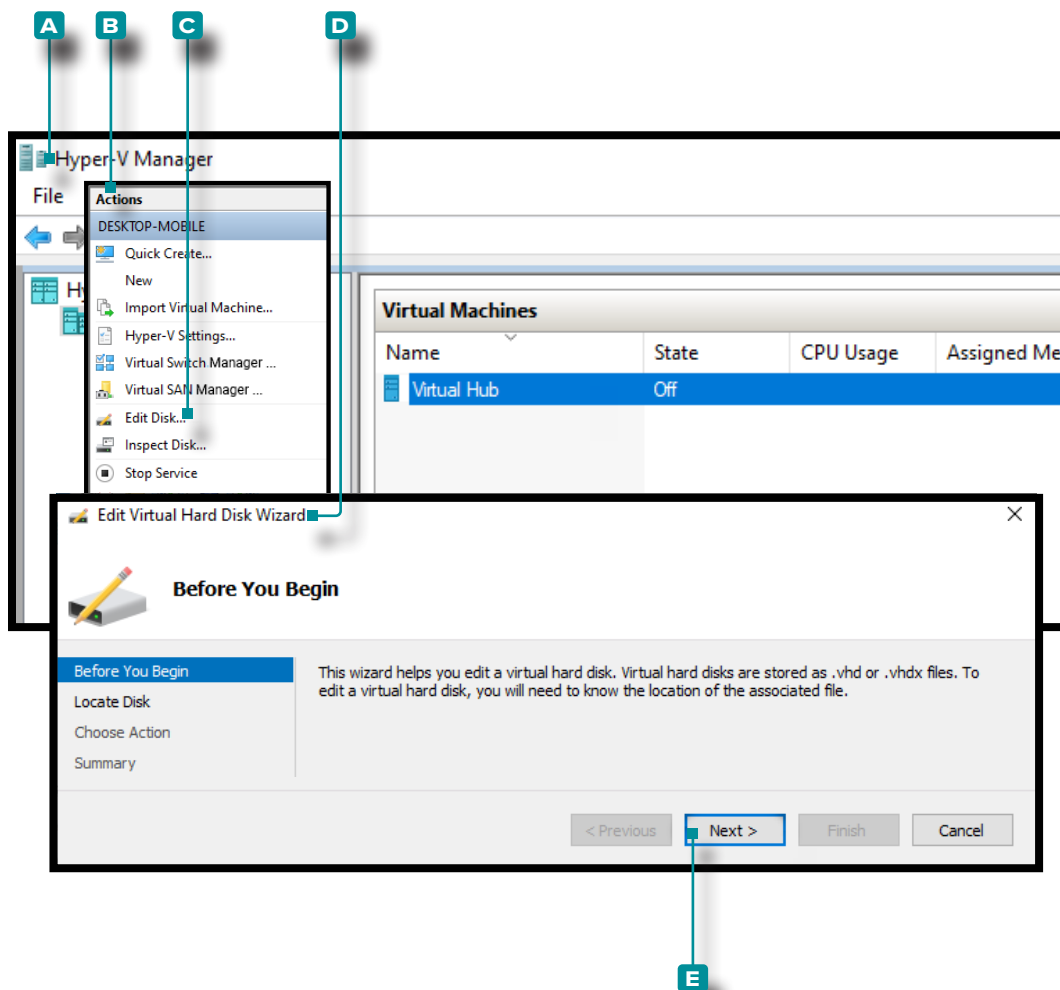

Resizing the Hard Drive Space with HyperV

(continued from previous page)



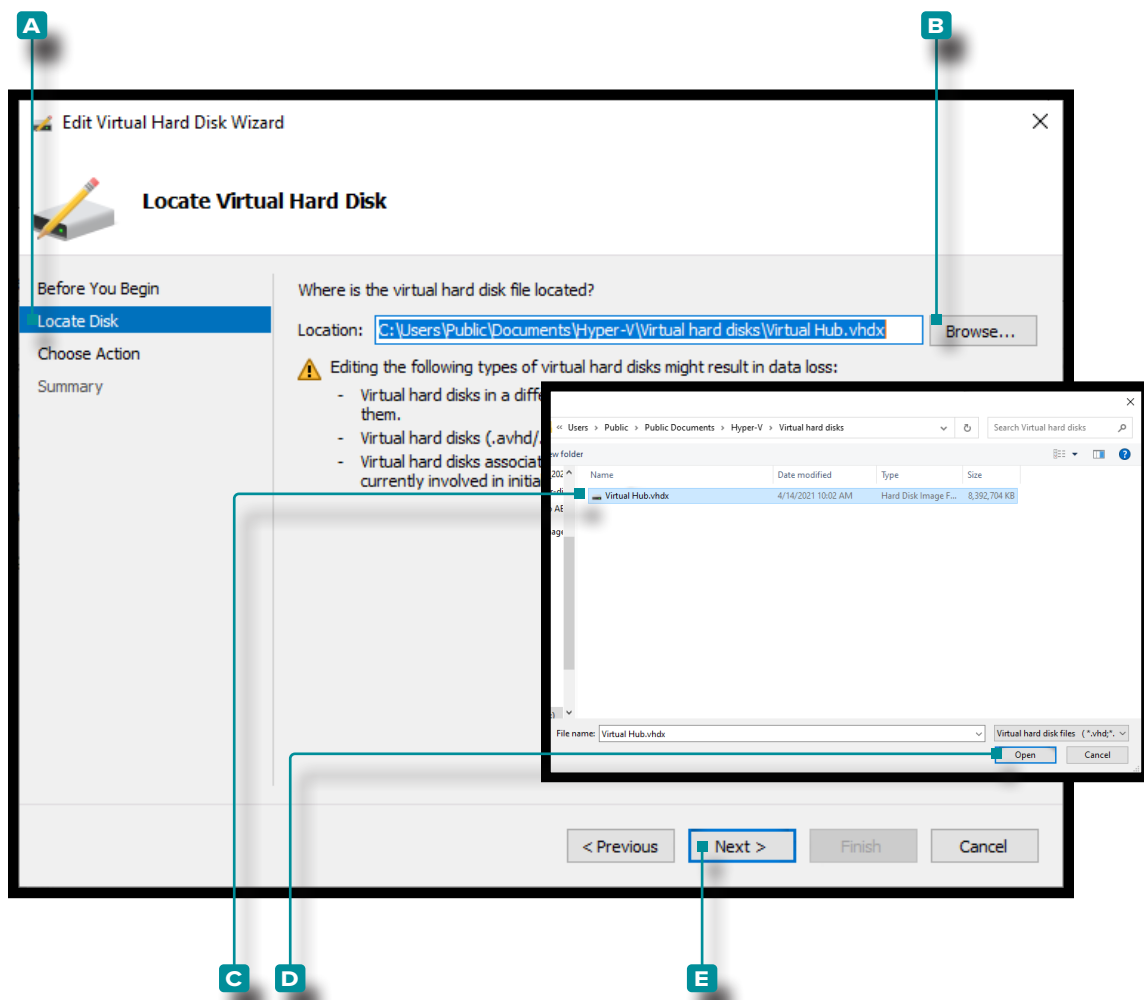

5. In the **A** Edit Virtual Hard Disk Wizard, Locate Disk page window, **click** **B** Browse button. **Click** to select the desired **C** .vhdx file in the file explorer window, then **click** the **D** Open button in the file explorer window.
6. **Click** the **E** Next button in the **A** Edit Virtual Hard Disk Wizard, Locate Disk page window.

(continued on next page)



Resizing the Hard Drive Space with HyperV

(continued from previous page)

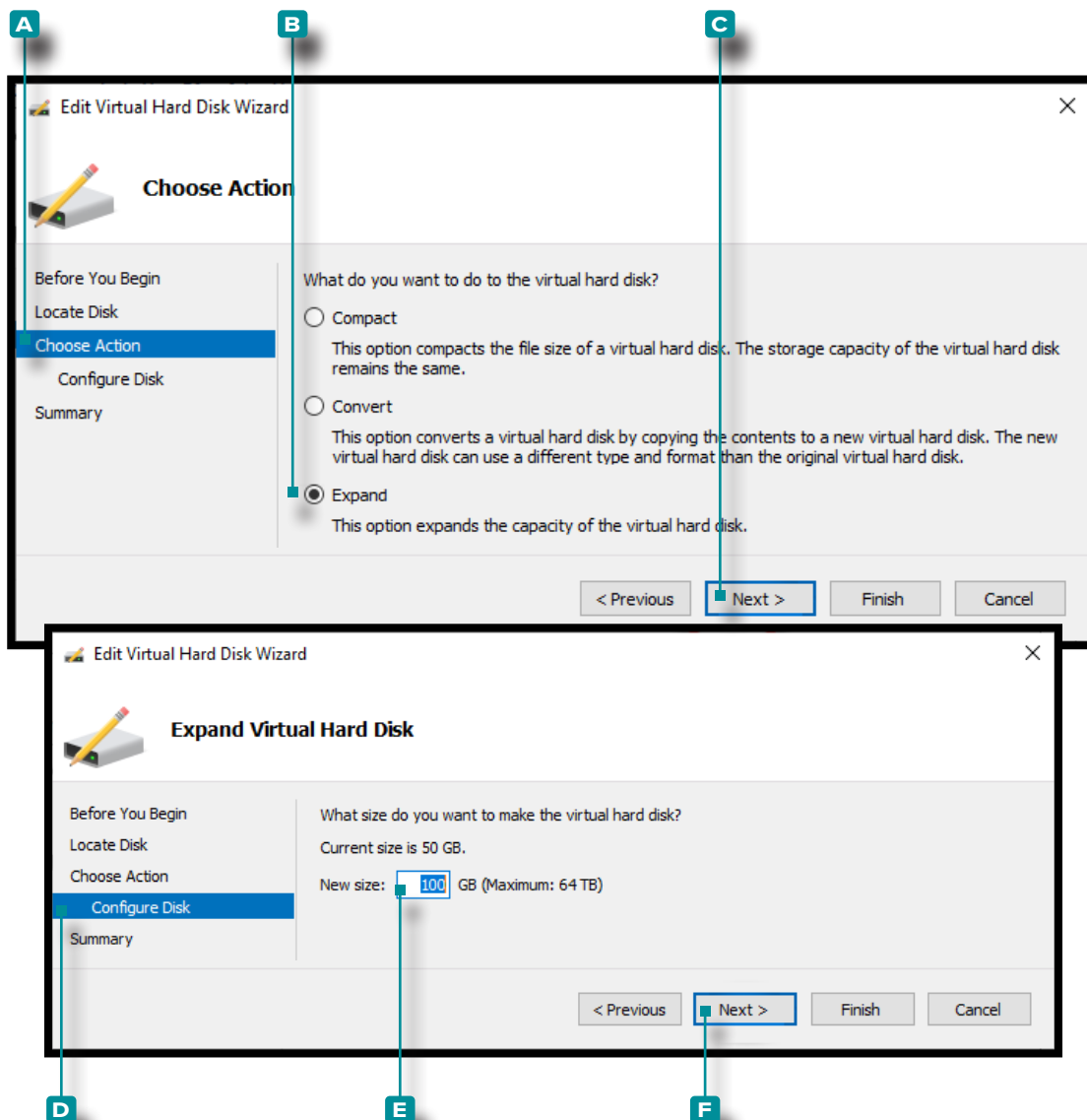

7. In the **A** Edit Virtual Hard Disk Wizard, Choose Action page window, **click**  the **B** Expand option then **click**  the **C** Next button.
8. In the **D** Edit Virtual Hard Disk Wizard, Configure Disk page window, **click**  and **enter**  the **E** New Size: in the provided field in the **B** Expand option, then **click**  the **F** Next button.

(continued on next page)



Resizing the Hard Drive Space with HyperV

(continued from previous page)

9. In the **A** Edit Virtual Hard Disk Wizard, Summary page window, **click**  the **B** Finish button in the Expand option to apply the changes or **click**  the **C** cancel button to discard any changes.
10. Confirm the disk space has been upgraded once the machine is running. (Open a terminal using the hypervisor to access The Hub VM; run `df -h`. Verify that `/dev/disk/by-label/nixos` is the desired size.)

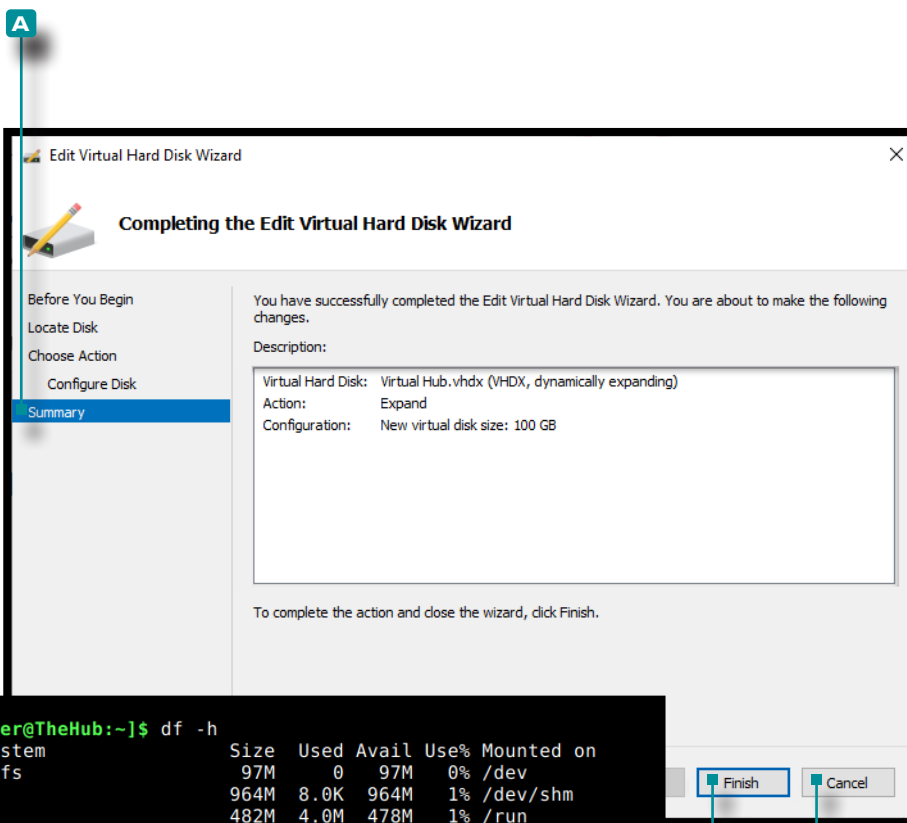

A

B

C

```
[rjguser@TheHub:~]$ df -h
Filesystem      Size  Used Avail Use% Mounted on
devtmpfs        97M   0    97M   0% /dev
tmpfs           964M   8.0K 964M   1% /dev/shm
tmpfs           482M   4.0M 478M   1% /run
tmpfs           964M  384K 964M   1% /run/wrappers
/dev/disk/by-label/nixos  98G   5.1G 88G    6% /
tmpfs           4.0M   0    4.0M   0% /sys/fs/cgroup
tmpfs           964M   72K 964M   1% /tmp
/dev/sda1       236M   28M 208M  12% /boot
tmpfs           193M   16K 193M   1% /run/user/78
tmpfs           193M   20K 193M   1% /run/user/1000
```



THE HUB SOFTWARE VIRTUAL APPLIANCE (VA) INSTALLATION

Troubleshooting Virtual Hard Drive Space Resize Failure

If resizing the virtual hard drive space fails to be successful after following the steps described in "Resizing The Hub VA Hard Drive Space" on page 21, perform the following:

1. Inside the VM, Resize partition, **sudo growpart /dev/sda 1**
2. Resize file system, **sudo resize2fs /dev/sda1**





THE HUB SOFTWARE VIRTUAL APPLIANCE (VA) INSTALLATION

The Hub VA Network Configuration

The Hub VA must be configured with a static IP address from the operating system, or using DHCP from the network router.

Requirements

Shell Access to The Hub VA using SSH or hypervisor

Configuration Details

- Static
 - The Hub IP
 - subnet mask
 - network gateway IP

Checking Network Status

Use the following command to check the network status:

```
networkctl status
```





THE HUB SOFTWARE VIRTUAL APPLIANCE (VA) INSTALLATION

Configuring The Hub VA Network

1. Log in to the Hub appliance terminal

a. Connect via SSH

```
ssh -l rjguser ${HUB_IP}
```

b. Or open a terminal using the hypervisor to access The Hub VM.

2. Run `networkctl list` to find The Hub network link name

In the following example, the link `ens33` is configured.

```
1 [rjguser@TheHub:~]# networkctl list
2  IDX LINK  TYPE      OPERATIONAL SETUP
3  lo    loopback carrier    unmanaged
4  ens33 ether   routable   configured
5  ens37 ether   degraded   configuring
6
7  3 links listed.
```

3. Navigate to the network configuration directory:

```
cd /etc/systemd/network/
```

4. Create a network file for the link found in step 2.

a. Copy the default ethernet configuration as a starting point or write a new file.

```
cp 99-ethernet-default-dhcp.network 1-primary-ens33.network
```

b. The file name must end in `.network` and be in the `/etc/systemd/network/` directory.





THE HUB SOFTWARE VIRTUAL APPLIANCE (VA) INSTALLATION

Configuring The Hub VA Network

5. Using a text editor (e.g., `nano` or `vim`), write a network file as follows

a. Configure the link to receive an IPv4 address by DHCP:

```
1  [Match]
2  Name=ens33
3
4  [Network]
5  DHCP=ipv4
```

b. To configure the link with a static address, let's use an example network with

iii. 24-bit netmask

iv. desired The Hub host IP: `172.16.0.42`

v. Network Gateway IP: `172.16.0.1`

```
1  [Match]
2  Name=ens33
3
4  [Network]
5  Address=172.16.0.42/24
6  Gateway=172.16.0.1
```

6. Reload the network configuration file:

```
networkctl reload
```

Find the complete list of `[Network]` options here: [https://freedesktop.org/software/systemd/man/systemd.network.html#\[Network\] Section Options](https://freedesktop.org/software/systemd/man/systemd.network.html#[Network] Section Options)

NOTE *Not all settings may be supported in the appliance.*





THE HUB SOFTWARE VIRTUAL APPLIANCE (VA) INSTALLATION

Licensing

A software license from RJG is required for The Hub software to operate after installation. The licensed provided will allow access to the software features purchased.

1. Start The Hub VM. Ensure that The Hub has an assigned static IPv4 address via DHCP lease as described in "The Hub VA Network Configuration" on page 27
2. Login to The Hub terminal.
 2. Acquire the system license information by performing the following steps:
 - in the shell, execute 'run_licenser'
 - send the output to RJG Support representative
 - (RJG) take pre-license information to the license machine and generate a license; relay license information to customer.
 3. From a web browser, navigate to The Hub.
 4. Create The Hub administrator user account (enter name and password).
 5. Enter license information in The Hub setup page.





THE HUB SOFTWARE VIRTUAL APPLIANCE (VA) INIT SERVICE CONFIGURATION

THE HUB INIT SERVICE CONFIGURATION

CAUTION Any changes to The Hub init requires the form to be completed in its entirety; for example, if TLS has already been enabled and configured, and a network share is being added at a later time, the TLS information must also be completed with the data backup and network share information.

The Hub Instance ID

The instance ID applies the saved configurations each time The Hub VA boots, and is included in each hub-init configuration file. The Hub instance ID is required to complete TLS and data backup/network share configuration. A typical format is iid-hub-`{site}`-`{NNNN}`, where 'NNNN' is a number increment when changes are made to The Hub init settings. Define a strategy for managing the instance ID as configuration changes are made over time.

Locating The Hub Instance ID

The Hub instance ID can be located on The Hub/Settings/System Settings page, or by using the terminal, issuing the command `cloud-init query instance-id`.

The image shows two overlapping screenshots. The left screenshot displays the 'System Settings' page in a web interface. The 'Hardware' section is expanded, showing the 'ID' field with the value '2f0898709-8890-3e3c-8d88-12458a06548'. The 'Cloud Init ID' field at the bottom is highlighted with a blue box and contains the value 'iid-hub-hibbing-0001'. The right screenshot shows the 'Hub-Init' configuration form in a web browser. The 'Instance ID' field is filled with 'hub-1244'. Under the 'TLS' section, 'Enable TLS?' is checked, and the 'Server Name' is '172.18.1.171'. Under the 'Backup & Network Share' section, 'Enable network share?' is checked, and the 'Remote Filesystem Type' is set to 'NFS'. The 'Remote Filesystem Resource' is '172.18.1.172:/nfsshare'. The 'Finalize' section has a 'Generate cidata.iso' button.





THE HUB SOFTWARE VIRTUAL APPLIANCE (VA) INIT SERVICE CONFIGURATION

TRANSPORT LAYER SECURITY (TLS) OVERVIEW

Transport layer security (TLS) is a data encryption of information sent between applications over the internet, often displayed as the padlock icon displayed on web browsers. TLS prevents private or sensitive information that is transmitted from being hacked.

TLS CONFIGURATION

Transport Layer Security (TLS) can be configured on The Hub VA system using the hub-init service.

REQUIREMENTS

- Certificate and Private Key Files in PKCS#7 Format
- Current cloud-init Instance ID (if any)
- Intended The Hub Server (Domain) Name

EXTRACTING PKCS#7 CERTIFICATE AND PRIVATE KEY FILES FROM PKCS#12 (OPTIONAL)

Extract and convert certificate and private key files into the required format if using the `.pfx` file.

```
1 #Extracting the client certificates:
2 openssl pkcs12 -in [yourfile.pfx] -clcerts -nokeys -out [cert.pem]
3
4 #Extracting the private key:
5 openssl pkcs12 -in [yourfile.pfx] -nocerts -nodes -out [key.pem]
```

CERTIFICATE CHAINS

If using certificate chains, bag attributes must not be present in the certificate. Also, if using a chain, the main certificate must be first, followed by the remaining bundle.





THE HUB SOFTWARE VIRTUAL APPLIANCE (VA) INIT SERVICE CONFIGURATION

TLS CONFIGURATION

CAUTION Any changes to The Hub init requires the form to be completed in its entirety; for example, if TLS has already been enabled and configured, and a network share is being added at a later time, the TLS information must also be completed with the data backup and network share information.

1. Navigate to **A** <https://hub-init.rjginc.com/>
2. Click **B** to select the **B** box next to "Enable TLS?".
3. Enter **C** a new cloud-init instance ID in the **C** Instance ID field:
 - a. A typical format is iid-hub-{site}-{NNN} , where "NNN" is an increment number when cloud-init settings are changed.
4. Select the PKCS#7 **D** certificate and **E** key files from the file system.
5. Enter **F** The Hub **F** server name.
6. Click **G** the **G** Submit button generate a hub-init.iso file.
7. Attach the ISO file to The Hub. A virtual CD-ROM drive may be required if one does not exist.
8. Reboot The Hub.

The screenshot shows the web form for configuring the Hub software virtual appliance. The form is divided into several sections:

- Metadata:** Instance ID:
- TLS:** Enable TLS? **B**
 - Certificate (.pem format) No file chosen
 - Private Key (.pem format) key.pem **E**
 - Server Name: **F**
 - Server IP (optional):
- Backup & Network Share:**
 - Server IP (optional):
 - Enable network share?
 - Remote Filesystem Type:
 - Remote Filesystem Resource:
 - Remote Filesystem Mount Options:
 - Use share for Hub job-data-backup secondary path?
- Finalize:** Generate cidata.iso: **G**

Callouts A through G are placed on the image to indicate the steps described in the text:

- A:** The URL <https://hub-init.rjginc.com/>
- B:** The "Enable TLS?" checkbox
- C:** The Instance ID field
- D:** The "Choose File" button for the certificate
- E:** The "Choose File" button for the private key
- F:** The Server Name field
- G:** The "Submit" button





THE HUB SOFTWARE VIRTUAL APPLIANCE (VA) INIT SERVICE CONFIGURATION

REQUIREMENTS

- Existing network share (CIFS or NFS)
- Network share resource details (IP address)
- Current Instance ID

DATA BACKUP & NETWORK SHARE CONFIGURATION

CAUTION Any changes to The Hub init requires the form to be completed in its entirety; for example, if TLS has already been enabled and configured, and a network share is being added at a later time, the TLS information must also be completed with the data backup and network share information.

1. Navigate to **A** <https://hub-init.rjginc.com/>
2. Enter **B** the cloud-init instance ID in the **B** Instance ID field.
3. Click **C** to select the **C** box next to "Enable Network Share?".
4. Click **D** to select the **D** Filesystem Type (NFS OR CIFS) from the dropdown menu.
5. Enter **E** the **E** Filesystem Resource name.
6. Enter **F** any desired **F** Filesystem Mount Options, separated by a comma without spaces.
7. Click **G** the **G** box to select the network share for The Hub job-data-backup as a secondary path.
8. Click **H** the **H** Submit button generate a `hub-init.iso` file.
9. Attach the ISO file to The Hub. A virtual CD-ROM drive may be required if one does not exist.
10. Reboot The Hub.

The screenshot shows the Hub-Init configuration form with the following fields and callouts:

- A**: Browser address bar showing `hub-init.rjginc.com`
- B**: Instance ID field containing `hub-1244`
- C**: Checkmark next to "Enable network share?"
- D**: "Remote Filesystem Type" dropdown menu set to "NFS"
- E**: "Remote Filesystem Resource" field containing `172.18.1.172/nfsshare`
- F**: "Remote Filesystem Mount Options" field (empty)
- G**: Checkmark next to "Use share for Hub job-data-backup secondary path?"
- H**: "Submit" button





THE HUB SOFTWARE VIRTUAL APPLIANCE (VA) INIT SERVICE CONFIGURATION

JOB BACKUP FILE CONFIRMATION

This test creates a job backup file to verify the job is backed up to the network share configured in "Data Backup & Network Share Configuration" on page 34.

NOTE A CoPilot system must be connected to The Hub software.

1. Start a job on the CoPilot system.
2. Verify the job is visible on The Hub software.
3. On the The Hub for Process Monitoring software, navigate to the Reports view and locate the job (the most-recently started job will be at the top of the list). **The 'Job End' time should be empty.**
4. Stop the job on the CoPilot system. Verify the job has a 'Job End' time on the The Hub for Process Monitoring software Reports view.

NOTE Cycles are not required for this test.

5. Locate the Job ID on the The Hub for Process Monitoring software Reports view, and **click** on the Job to open the Job Overview Report. The Job ID is the right-most text segment in the browser URL after the last forward slash.

```
Sm9ifDAw0jUw0jU2Xzgy0jMy0jc1XzE20DIwMTU1NDA3NzA
```

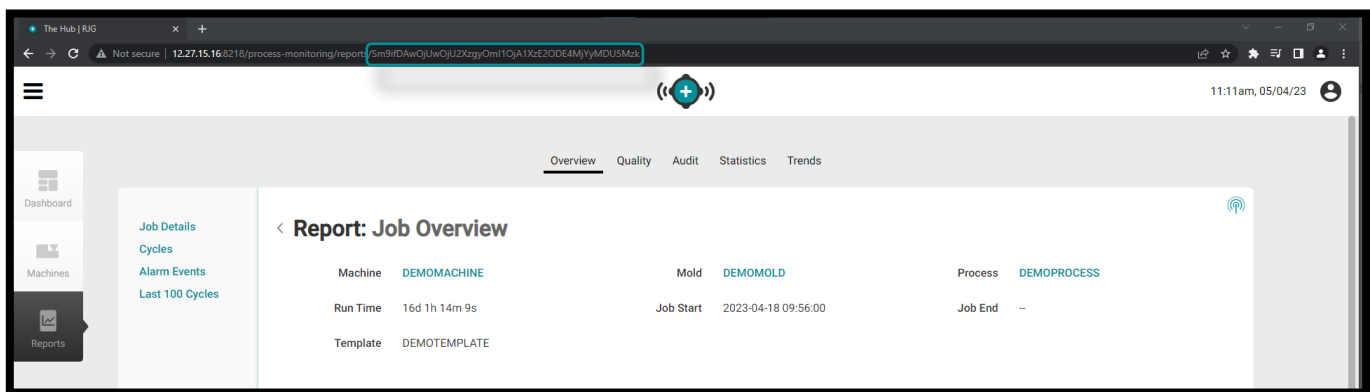

6. Log in to the console of The Hub software using a hypervisor or a terminal client. Search for the Job ID found in the previous step in the terminal using the following command:

```
fd jobID /mnt/backup/
```

7. The job backup file should be located on the network share; if the job backup file is not located on the network share, refer to "Troubleshooting the Network Share Mount" on page 38.





THE HUB SOFTWARE VIRTUAL APPLIANCE (VA) INIT SERVICE CONFIGURATION

NON-JOB BACKUP FILE CONFIRMATION

This test creates a non-job backup file to verify the file is backed up to the network share configured in "Data Backup & Network Share Configuration" on page 34.

1. Log in to The Hub software console using a hypervisor or terminal client.
2. In the terminal, issue the command:

```
s start backup-hub-non-job-data.service
```

3. Verify that a non-job backup file exists on The Hub software network share by issuing the following command:

```
l fd hub-non-job-backup /mnt/backup/
```

The job backup file should be located on the network share; if the job backup file is not located on the network share, refer to "Troubleshooting the Network Share Mount" on page 38.





THE HUB SOFTWARE VIRTUAL APPLIANCE (VA) CONFIGURATION TROUBLESHOOTING

TROUBLESHOOTING THE NETWORK SHARE

Use the following to troubleshoot the network share and The Hub software network share and backup settings if job backup or non-job backup files are not located on the network share during the tests on page 35 and page 36.

Locate Network Share Files

1. Verify whether the files can be located on the mounted share by issuing the following command in the terminal:

```
1 ls /mnt/backup/
```

A listing of files should be displayed in the top level of the mounted network share; see the following example:

```
2 [rjguser@TheHub:~]# ls /mnt/backup/
3 myfile    foo    bar    anotherfile    reallylongfilename
4 myfile2   moo
```

2. If no files are present but it is known that the share contains files, or an error message such as “No such file or directory” is displayed, contact RJG Support or continue to the following troubleshooting steps. If the network share is not mounted as expected, RJG Support will assist in configuring the network share.





THE HUB SOFTWARE VIRTUAL APPLIANCE (VA) INIT CONFIGURATION TROUBLESHOOTING

Troubleshooting the Network Share Mount

Perform the following steps to determine why the network share is not mounted.

⚠ CAUTION *These steps may require consultation with RJG Support to interpret and prevent any potential data loss.*

Testing the Environment File

The Hub VA mounts the network share based on data configured in an environment file. The entries should be able to be related back to the settings entered on the hub-init service.

View the env file to check for spelling mistakes or anything unexpected by issuing the following terminal command:

```
1 bat /etc/dynamic-mount/env
```

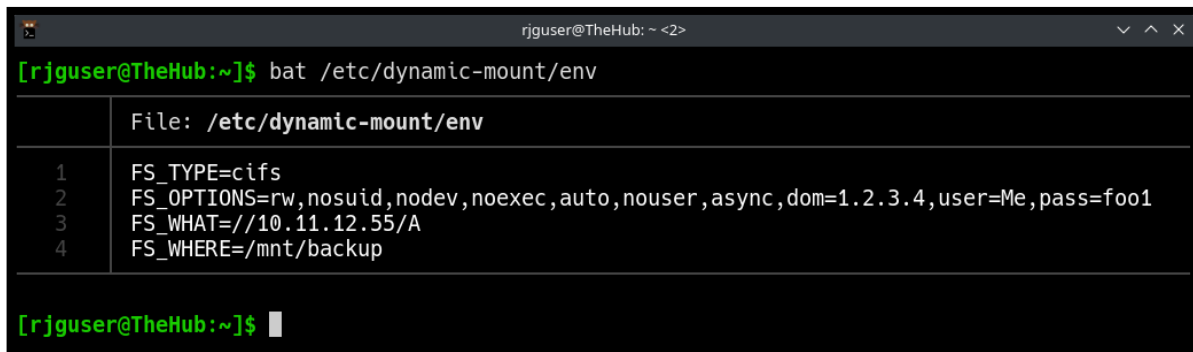

```
[rjguser@TheHub:~]$ bat /etc/dynamic-mount/env
```

	File: /etc/dynamic-mount/env
1	FS_TYPE=cifs
2	FS_OPTIONS=rw,nosuid,nodev,noexec,auto,nouser,async,dm=1.2.3.4,user=Me,pass=foo1
3	FS_WHAT=//10.11.12.55/A
4	FS_WHERE=/mnt/backup

```
[rjguser@TheHub:~]$
```





THE HUB SOFTWARE VIRTUAL APPLIANCE (VA) INIT CONFIGURATION TROUBLESHOOTING

Service

The **dynamic-mount.service** is responsible for mounting the network share.

In the terminal, issue the command:

```
1 s is-active dynamic-mount.service
```

The desired status is 'active':

```
1 [rjguser@TheHub:~]# s is-active dynamic-mount.service
2 active
```

Other possible states are possible; refer to the Systemd Unit State Table below:

SYSTEMD UNIT STATE	MEANING
active	running, started, bound (depends on the unit type)
inactive	not running, stopped, unbound
activating	in the process of being activated (started)
deactivating	in the process of being deactivated (stopping)
failed	the process returned an error code, crashed, timed-out, etc.

Testing the Mount

The mounting of the network filesystem (in coordination with the Linux kernel) is achieved via `systemd-mount`; check for the mount by name using the `systemd` naming scheme.

In the terminal, issue the command: `s is-active mnt-backup.mount`

The desired status is 'active':

```
1 [rjguser@TheHub:~]# s is-active mnt-backup.mount
2 active
```





THE HUB SOFTWARE VIRTUAL APPLIANCE (VA) INIT CONFIGURATION TROUBLESHOOTING

Testing Connectivity

Check the network connectivity between The Hub software and the network share host.

In the terminal, ping the IP address of your network share:

```
1 ping 10.11.12.55
```

```
rjguser@TheHub: ~  
[rjguser@TheHub:~]$ ping 10.11.12.55  
PING 10.11.12.55 (10.11.12.55) 56(84) bytes of data.  
64 bytes from 10.11.12.55: icmp_seq=1 ttl=64 time=0.391 ms  
64 bytes from 10.11.12.55: icmp_seq=2 ttl=64 time=0.395 ms  
64 bytes from 10.11.12.55: icmp_seq=3 ttl=64 time=0.364 ms  
64 bytes from 10.11.12.55: icmp_seq=4 ttl=64 time=0.355 ms  
64 bytes from 10.11.12.55: icmp_seq=5 ttl=64 time=0.343 ms  
64 bytes from 10.11.12.55: icmp_seq=6 ttl=64 time=0.366 ms  
64 bytes from 10.11.12.55: icmp_seq=7 ttl=64 time=0.420 ms  
^C  
--- 10.11.12.55 ping statistics ---  
7 packets transmitted, 7 received, 0% packet loss, time 6122ms  
rtt min/avg/max/mdev = 0.343/0.376/0.420/0.024 ms  
[rjguser@TheHub:~]$
```

If all of the above options have been exhausted, and it could not be verified that the network share is mounted, please contact RJG Support.





THE HUB SOFTWARE VIRTUAL APPLIANCE (VA) RESTORING DATA

RESTORING DATA

The preferred way to restore job data is via the network share.

If job data zip files are retained on a network share, and follow the above steps to create a new The Hub VA instance, The Hub will automatically begin importing the job backups after rebooting in step 2.c.

Restore Job Data from a Network Share (Preferred Method)

Backups will automatically begin importing when the following conditions are met:

1. Job backup files reside on the network share and
2. The network share is configured on the new The Hub VA instance.

Restore Job Data by Upload (Alternate Method)

Restore the job .zip files may be restored by copying the files into The Hub data backup primary path.

1. Copy job data backups using Secure copy protocol (SCP).
(For example, use the 'WinSCP' implementation on Microsoft Windows.)
2. Connect the SCP program to The Hub (details vary).
3. Upload the job data zip files to The Hub: move the files into `/opt/rjg/datafiles`

Backups will automatically begin importing after a short time.

It may be necessary to restart The Hub service to trigger the import. This can be achieved with the following command:

```
systemctl restart esm-jetty
```





THE HUB SOFTWARE VIRTUAL APPLIANCE (VA) RESTORING DATA

Restore Non-Job Data

Use the terminal and `pg_restore` to recover the non-job data (Users, Roles, EULA acknowledgments.)

1. Move the `hub-non-job-backup_date.zip` file to The Hub software. Use one of the two methods described in "Restore Job Data from a Network Share (Preferred Method)" or "Restore Job Data by Upload (Alternate Method)" on page 41.

2. Stop The Hub software application services:

```
1 s stop esm-jetty esm-collector
```

3. Create a folder to work in:

```
1 [rjguser@TheHub:~]# mkdir /tmp/restore
2
3 [rjguser@TheHub:~]# cd /tmp/restore
4
5 [rjguser@TheHub:/tmp/restore]#
```

4. Unpack the `hub-non-job-backup_date.zip` file:

(this is just an example; reference the full path to your actual hub-non-job-backup file)

```
1 [rjguser@TheHub:/tmp/restore]# unzip /mnt/backup/hub-non-job-back
up_2023-04-20__19-41-57_-0400.zip
```

5. Import the non-job data:

```
1 pg_restore -Upostgres -d postgres /tmp/restore
```

⚠ CAUTION Please note an error message will be displayed; this should be ignored. The error is displayed below for reference.

```
1 pg_restore: error: COPY failed for table "documents_role": ERROR:
duplicate key value violates unique constraint "documents_role_pkey"
```

6. Restart the Hub services:

```
1 s start esm-collector esm-jetty
```





THE HUB SOFTWARE REPRESENTATIONAL STATE TRANSFER (REST) APPLICATION PROGRAM INTERFACE (API)

The Hub's REST API is accessible through the same domain as the web interface. For example, if The Hub and API are accessible from a network location.

NOTE *This information is current and applicable as dated 12/08/2021; RJG makes no guarantee that this information is or will be applicable to future release(s) of this product.*

REQUEST ENDPOINT FOR JOBS

Use the endpoint to get additional details for a specific job.

RESPONSE PROPERTIES

PROPERTY	TYPE	DESCRIPTION
id	String	The ID used for referencing the job.
machineName	String	The name of the machine.
moldName	String	The name of the mold.
processName	String	The name of the process.
startTime	Integer	The starting timestamp for the job (in milliseconds).
endTime	Integer	The ending timestamp for the job (in milliseconds).
runTime	Integer	The total duration for the job (in milliseconds).
downTime	Integer	The total down time for the job (in milliseconds).
machineState	String	The last machine state for the job; possible values are "Running", "Stopped", "Down", or "Syncing".
sortState	String	The last sorting state for the job; possible values are "Good" or "Reject".
alarmState	String	The last alarm state for the job; possible values are "Good", "Warning", "Alarm", "No Alarms Set", or "No Alarm Tool".
machineMatch	String	The last machine match value for the job; possible values are "Good", "Warning", "Alarm", or "No Match".





THE HUB SOFTWARE REPRESENTATIONAL STATE TRANSFER (REST) APPLICATION PROGRAM INTERFACE (API)

RESPONSE PROPERTIES *(continued)*

PROPERTY	TYPE	DESCRIPTION
materialMatch	String	The last material match value for the job; possible values are “Good”, “Warning”, “Alarm”, or “No Match”.
moldMatch	String	The last mold match value for the job; possible values are “Good”, “Warning”, “Alarm”, or “No Match”.
connected	Boolean	Indicates whether the machine is currently connected or disconnected.
processCurrent	Boolean	Indicates if the current machine, mold, and process for the job matches the current CoPilot configuration.
excessiveRejectCount	Integer	The total number of times that an excessive reject output was triggered.
sortingDisabledCount	Integer	The total number of cycles that ran while sorting was disabled.
secondaryVpCount	Integer	The total number of times that V→P has fired off a secondary control.
currentTemplatedId	String	The ID used for referencing the currently configured template.
rejectPercent	Float	The percentage of reject cycles when compared to total cycles.
downTimePercent	Float	The percentage of down time when compared to the total run time.
totalCycles	Integer	The total number of cycles that the job has completed.
goodCycles	Integer	The number of cycles in the job that were flagged as “Good”.
rejectCycles	Integer	The number of cycles in the job that were flagged as “Reject”.
alarmCycles	Integer	The number of cycles that triggered an alarm state.
alarms	Array	A list of Alarm Objects (see below).





THE HUB SOFTWARE REPRESENTATIONAL STATE TRANSFER (REST) APPLICATION PROGRAM INTERFACE (API)

ALARM OBJECTS

PROPERTY	TYPE	DESCRIPTION
name	String	The name of the alarm.
alarmCountAbove	Integer	The number of cycles during which the named value was above the alarm limit.
alarmCountBelow	Integer	The number of cycles during which the named value was below the alarm limit.



LOCATIONS / OFFICES

USA	RJG USA (HEADQUARTERS) 3111 Park Drive Traverse City, MI 49686 P +01 231 947-3111 F +01 231 947-6403 sales@rjginc.com www.rjginc.com	ITALY	NEXT INNOVATION SRL Milano, Italy P +39 335 178 4035 sales@it.rjginc.com it.rjginc.com
MEXICO	RJG MEXICO Chihuahua, Mexico P +52 614 4242281 sales@es.rjginc.com es.rjginc.com	SINGAPORE	RJG (S.E.A.) PTE LTD Singapore, Republic of Singapore P +65 6846 1518 sales@swg.rjginc.com en.rjginc.com
FRANCE	RJG FRANCE Arnithod, France P +33 384 442 992 sales@fr.rjginc.com fr.rjginc.com	CHINA	RJG CHINA Chengdu, China P +86 28 6201 6816 sales@cn.rjginc.com zh.rjginc.com
GERMANY	RJG GERMANY Karlstein, Germany P +49 (0) 6188 44696 11 sales@de.rjginc.com de.rjginc.com	KOREA	CAEPRO Seoul, Korea P +82 02-2113-1870 sales@ko.rjginc.com www.caepro.co.kr
IRELAND/UK	RJG TECHNOLOGIES, LTD. Peterborough, England P +44(0)1733-232211 info@rjginc.co.uk www.rjginc.co.uk		